



Operating Manual

Supermarket Refrigerator Series



I. Foreword

Dear customer:

Welcome and thank you for using our fan cooling supermarket display refrigerator. As a new product with advanced international level researched and developed by the company according to the market needs, this product fully absorbs the advantages of similar domestic and foreign products and has the structure optimized based on the original knock-out products of the company, so that the product is more concise and generous and can be used to sell food and decorate the commodity section.

This series of supermarket refrigerators may be normally used under 30°C environment temperature and 60%RH relative humidity and is very suitable for Chinese conditions. It is the first choice for various supermarkets, multiple shops and subsidiary food markets to display and sell cooked food, beverage, fruit and vegetables and for the hotels and collective meal units for cold storage and fresh-keeping of food.

With good exhibition, the supermarket refrigerator adopts cyclopentane foaming with excellent thermal insulation performance, copper tube finned evaporator, high EER horizontal rotary unit and single-layer multistage optimization air curtain, effectively reducing heat exchange with the outside world, so as to guarantee high product performance and achieve significant energy saving effect!

- ★The main components are of well-known domestic and foreign brands and reliable performance.
- ★Integrated design, simple structure and convenient maintenance.
- ★Ultra-large capacity size, much placement space and good display performance.
- ★Single-layer multistage optimization air curtain, back air outlet technology application, quick cooling and uniform refrigerator temperature.
- ★Each layer is designed with LED goods shelf light, which increases the display effect and is more energy-saving than ordinary fluorescent lamp.
- ★The trim strips have many colors for choice to show different effects as needed.
- ★The microcomputer temperature controller may accurately control the refrigerator temperature, defrosting and other parameters and store the food with high freshness.

For better services, please carefully read this manual before use.

II. Main structure

This series of supermarket refrigerator mainly consists of the refrigerator body, foam end plate, evaporator, fan unit, front and top decorative parts, exhaust system, temperature control parts, thermostatic expansion valve or capillary tube, bottom unit parts, end plate parts, shelves and other accessories. The specific structural layout is shown in the following sectional view:

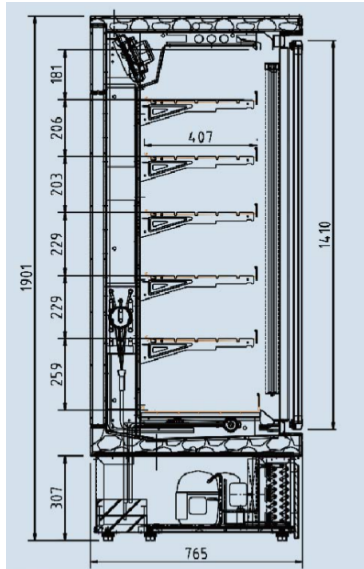

III. Main technical parameters

Parameter Series	Model	Rated power supply (V/Hz)	Service power (W)	Temperature range (°C)	Temperature controller model	Refrigerant	Dimensions (L mm W mmH mm)
Commercial supermarket series	KX-BGC3	220/50	1530	2~8	C401-KX	R404a	2550*800*1910

IV. Open-box inspection

1. Check the goods received, check whether the packaging box is seriously damaged, require the carrier to sign and approve, and timely notify the company or the company's agent for solving.
2. Check whether the parts are damaged according to the product shipping list. For any problem, please timely negotiate with the company or the company's agent for solving.
3. Do not lift the refrigerator end plate and skirt board when moving the refrigerator to avoid damage.
4. Do not tread to avoid damage to the refrigerator.
5. Timely check whether the parts are loose, whether the refrigeration pipeline is damaged and whether the electric wires and electric parts are damaged or possibly affect normal operation of the refrigerator during installation and debugging and timely handle if any. For any problem difficult to solve, timely notify the agent to repair.

V. Service environment and requirements

1. This series of refrigerator has the best using effect in the air conditioning environment (temperature not higher than 30°C and relative humidity not more than 60%). If the environment temperature exceeds 30°C, the refrigeration effect of the refrigerator will be affected; if the ambient humidity of

the refrigerator exceeds 60%, the refrigerator defrosting effect will be affected and the power consumption in the wet conditions will be increased.

2. When the service environment exceeds 30°C and the relative humidity is above 65%, the water drops will accumulate and block in some exhaust air grille holes. The water in the grille may be absorbed regularly with sponge block to keep the exhaust air grille dry.
3. The strong air flow is not allowed around the refrigerator to interfere with the refrigerator air curtain (such as ceiling fan installed at the top of the refrigerator and the air conditioner outlet air against the refrigerator opening). Such air flow will destroy the air curtain and directly affect the refrigerator cooling effect. The air flow shall be kept away from heat to avoid heat radiation and hot air interference.
4. The refrigerator shall be installed on flat, hard and dry ground to ensure that the condenser exhausts air smoothly. The water shall be discharged regularly or the sewer pipe is connected to the sewer.

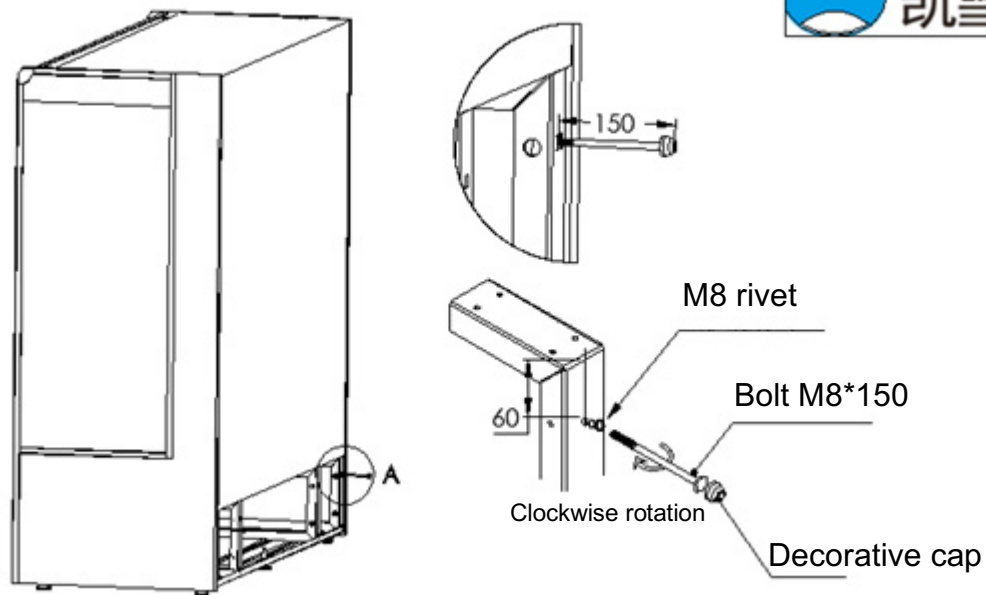

Note:

To ensure good heat dissipation environment of the refrigerator, the manual is attached with 2 sets of M8 bolts and decorative caps. Before using the refrigerator, screw the bolt in the rear pre-positioned rivet according to the figure, ensure that the screw outreach is no less than 140mm and finally lock the decorative cap in the screw. Gently push the refrigerator to the using area, so that the decorative cap is slightly against the wall.

★Warning: Install in strict accordance with the requirements; otherwise, the refrigeration performance will be affected!

VI. Precautions for use

1. Precautions in boot
 - (1) Check whether the power supply is live and whether the voltage is normal;
 - (2) Insert the power plug, turn on the refrigeration switch and start up after delay for 3min;
 - (3) Do not store goods in the refrigerator before the refrigerator temperature reaches normal temperature.
2. Precautions in shutdown: turn off the refrigeration switch or unplug the power plug. Disconnect the power if the refrigerator is not used for long time.
3. Ensure that the power plug of the refrigerator has reliable grounding wire. 确保陈列柜电源插头有可靠的接地线。
4. At the initial stage of using the refrigerator, observe whether the thermostatic expansion valve or

capillary tube is working normally. In case of ice jamming or filth blockage, eliminate immediately.

5. The goods on the high level shelves shall not block the air curtain to ensure good thermal insulation effect of the air curtain.
6. The residue shall be timely cleaned to prevent the residue from falling into the sewer port and blocking discharge of the defrosting water in the refrigerator.
7. There is high-speed running motor in the refrigerator. Be careful when opening the pallet. In case of exception in the motor operation, turn off the power before maintenance.
8. To ensure the use performance and cleanliness, the supermarket refrigerator must be thoroughly cleaned each week to remove the dirt and non-emptied water.

VII. Maintenance and repair

1. In the refrigerator maintenance, the maintenance personnel must have certain refrigeration technology knowledge and operation skills. The refrigerator shall be specially managed to ensure reasonable use.
2. Cut off the power before maintenance of the refrigerator.
3. The refrigerator cannot be rinsed with water directly and shall be cleaned according to the following steps:
 - (1) Stop the operation of the refrigeration system according to the shutdown procedures and cut off the power in the refrigerator;
 - (2) Move away the goods in the refrigerator and remove the pallet and inner seal plate;
 - (3) Scrub the shelves and other places to be cleaned and pay attention to drying and ventilation of the electric parts;
 - (4) Install the disassembled parts in sequence, start the refrigeration system and load the goods after the refrigerator temperature is normal.
4. Protect the evaporator during maintenance to prevent refrigerant leakage due to bump.
5. Shut down according to the shutdown method in the operating manual before removing the compressor, expansion valve, dry filter, evaporator and other parts in the system for repair.
6. Modulator tube replacement: unscrew the water joint, take down the damaged modulator tube and put the new modulator tube in the light base.
7. Regularly clean the unit condenser (every three months), keep the heat exchange plate clean and ensure smooth heat dissipation. Cleaning steps: shut down first, remove the dash panel, brush the dust along the aluminum fins and finally clean the fouling between the aluminum fins with compressed air or water. Do not splash the water on the motor and other electrical elements.
8. The common faults and maintenance methods for this series of refrigerator are as follows:

No.	Fault phenomenon	Causes	Solutions
1	The refrigerator is not electrified	Fuse blowing out or leakage short-circuiter disconnected	Replace the fuse or connect the short-circuiter
2	The fan motor is running but cannot refrigerate	1. Refrigerant leakage 2. Compressor damage 3. Unit electric appliance out of order 4. Under defrosting 5. Other reasons in the refrigeration system	1. Notify the maintenance department to repair 2. Notify the maintenance department to repair 3. Notify the maintenance department to repair 4. Running normally after defrosting determination 5. Notify the maintenance department to repair
3	Fluctuation in the	1. High condensing pressure	1. Clean the condenser or repair the condenser

	refrigerator temperature	and frequent start of compressor 2. Too low suction pressure 3. Expansion valve out of order or capillary tube blocked 4. Temperature controller out of order 5. Too large humidity 6. Air curtain interference by air flow	motor 2. Notify the maintenance department to repair 3. Notify the maintenance department to repair 4. Notify the maintenance department to repair 5. Increase defrosting times 6. Prevent the air curtain from being intervened by air flow
4	The refrigerator temperature is higher than the set value	1. Refrigeration system fault 2. Electrical control fault 3. Too high environment temperature 4. Too large environment humidity 5. Air curtain interference by surrounding strong air flow	1. Notify the maintenance department to repair 2. Notify the maintenance department to repair 3. Improve the refrigerator service environment 4. Increase defrosting times 5. Avoid strong air flow interference
5	No air curtain and not refrigerate	1. Fan motor damaged in the refrigerator 2. Return air inlet blocked 3. Serious frost blocking	1. Notify the maintenance department to repair 2. Move away the blocking objects 3. Forced defrosting
6	Incomplete defrosting of evaporator	1. Defrosting controller fault 2. Too low refrigerator temperature setting	1. Notify the maintenance department to repair 2. Adjust the temperature controller to the set value
7	Abnormal sound in the refrigerator	Fan blade loose	Fasten the fan blade after shutdown
8	Refrigeration failure or high refrigerator temperature	Compressor unit fault	Notify the maintenance department to repair

VIII. Electrical principle and microcomputer operating manual

(1) Electrical schematic diagram

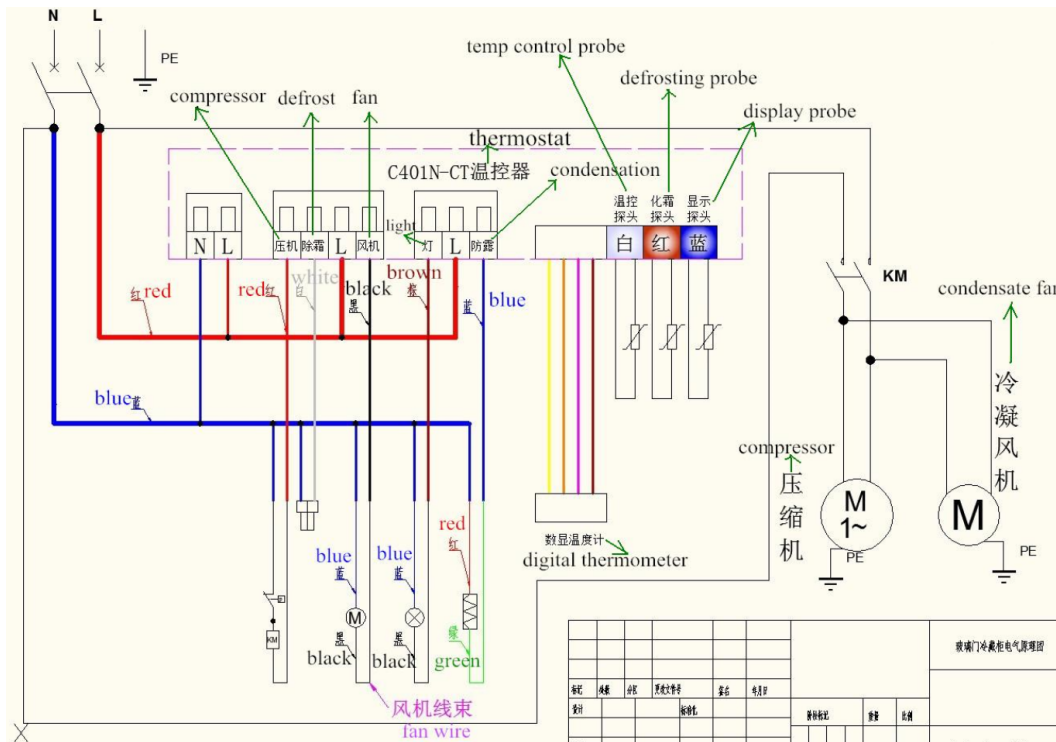

Microcomputer Controller Manual

Instructions for microcomputer controller C204-KX

1.1 Display description:

Display two and half digits (at most display -188) and 3 marks (refrigeration, defrosting and alarm).

- 1.Refrigeration mark: the indicator light on indicates that the system enters refrigeration and the light flashing (frequency 1Hz) indicates refrigeration output delay.
- 2.Alarm, indicating occurrence of alarm.
- 3.Defrosting mark, indicating whether the system is defrosting.



FIG 1

Note: The alarm icon  is flashing at the rate of 2Hz when setting the parameter.

1.2 Technical parameters

Relay output: 30A, 240VAC, maximum load 25A, 240VAC, used for compressor control;

Power supply: 230VAC, 50/60Hz;

Temperature sensor 1: measure the temperature in the refrigerator;

Temperature sensor 2: measure the evaporator temperature

Temperature measurement range: -45~99°C;

Temperature measurement accuracy: ±1°C(@-30~50°C)

Power voltage: 230VAC, 50/60Hz;



Overall power consumption: less than 1.5VA;

Controller operation



1.3 View the upper and lower limits of the setting temperature:



Press  for 1s to view the upper limit of the setting temperature (start refrigeration if the temperature is higher than the upper limit);

Press  for 1s to view the lower limit of the setting temperature (stop refrigeration if the temperature is below the lower limit);



Press  and  simultaneously for 1s to view the evaporator temperature.

Press  for more than 3s to enter or exit defrosting state (unable to enter the defrosting state if the parameter D1=0).

Press  and  simultaneously for more than 3s to enable or disable forced refrigeration (unable to enter the forced refrigeration state if CC = 0).









Press  and  simultaneously in power-on to display that the default will be recovered. The nixie tube displays "CF".

2. Modify parameters





The controller parameters may be set by the keys. The parameters are classified into types A and B. A series are common parameters and entered by pressing  for 3s. Type B parameters are protected parameters and shall be entered by pressing  and  simultaneously for 3s.

☆ Warning: Do not change type B parameter setting at will. Make adjustment, if required, under the guidance of professional after-sales personnel.



2.1 Visit type A parameters

1. Press  for more than 3S and the nixie tube displays the parameter code "P1";
- 2 Press  and  to roll the parameter name;
- 3 Press  to display corresponding parameter value;
- 4 Press  or  to increase or decrease the value;
- 5 Press  to temporarily store the modified value and return to display parameter;
- 6 Repeat 2~5 to modify other parameters;
- 7 Press  for more than 3s to store the modified parameter and exit the parameter setting procedure.

2.2 Visit typeB parameters

1. Press  and  simultaneously for more than 3S and the nixie tube displays the parameter code "0";
- 2 Press  and  to roll the parameter name;

3 Press **SET** to display corresponding parameter value;

4 Press  or  to increase or decrease the value;

5 Press **SET** to temporarily store the modified value and return to display parameter;

6 Repeat 2~5 to modify other parameters;

7 Press **SET** for more than 3s to store the modified parameter and exit the parameter setting procedure.

If the defrost sensor is shielded or faulty, defrosting will finish at the maximum defrosting time (parameter dp).

Note: The parameter dt is not displayed when the parameter/2 is--.

2.3 Fault code

Alarm code	Fault description
E1	Sensor 1 fault
E2	Sensor 2 fault
Lo	Sensor 1 low temperature alarm
Hi	Sensor 1 high temperature alarm
dF	Defrosting display

Note: In case of high temperature alarm and low temperature alarm, the alarm code (Lo or Hi) and the temperature display alternately.

2.4 Parameter list

Parameter	Description	Category	Minimum	Maximum	Unit	Default
/0	Sensor measurement stability	B	1	15	-	4
/1	Offset of sensor 1	A	-5	5	°C	0
/2	Offset of sensor 2	A	-5	--	°C	--
P1	Upper limit of setting temperature	A	r1	r2	°C	4
P2	Lower limit of setting temperature	A	r1	r2	°C	0
r1	Minimum setting value	B	-40	r2	°C	-10
r2	Maximum setting temperature	B	r1	90	°C	15
r3	Operating mode	B	0	1	-	0
c0	Delay after compressor power-on	B	0	99	Min	0
c1	Minimum downtime of compressor	B	0	99	Min	4
c2	Shortest running time of compressor	B	0	99	Min	7
c3	Delay between two adjacent starts	B	0	99	Min	10
c4	Compressor working time in case of sensor fault	B	0	99	Min	15
c5	Compressor downtime in case of sensor fault	B	1	99	Min	5

ct	Time after compressor fault shutdown	A	10	60	Min	20
cc	Minimum running time of compressor in forced refrigeration	A	0	199	Min	0
c6	Alarm shielding time after termination of forced refrigeration	A	0	199	Min	0
d1	Defrosting cycle	A	0	199	Hour	4
d2	Power-on defrosting	A	0	1	-	0
dp	Defrosting time	A	1	99	Min	15
dt	Defrosting final temperature	A	-40	90	°C	4
d6	Defrosting display	B	0	2	-	2
d8	Alarm shielding time after defrosting	B	0	99	Min	90
dd	Water drop time	B	0	15	Min	2
A0	Overtemperature alarm	A	0	20	K	0
Ad	Alarm delay	B	0	99	Min	1

Operating manual of ECS-180neo temperature controller

1. Operation and display panel





2. Technical parameters

- 1) Temperature control range: $-50^{\circ}\text{C} \sim 85^{\circ}\text{C}$ Temperature resolution: 0.1°C
- 2) Temperature measurement accuracy: $\pm 1^{\circ}\text{C}$ at $-40^{\circ}\text{C} \sim 50^{\circ}\text{C}$, $\pm 2^{\circ}\text{C}$ at $51^{\circ}\text{C} \sim 70^{\circ}\text{C}$, $\pm 3^{\circ}\text{C}$ for other temperatures
- 5) Power voltage: $220\text{VAC} \pm 10\%$ 50/60Hz
- 6) Overall power consumption: $< 3\text{W}$



3. Indicator light status description

Indicator light	Symbol	Status	Meaning
Setting indicator	set	On	Parameter setting
		Off	Measurement and control status
Refrigeration indicator	❄️	On	Refrigeration working
		Off	Refrigeration stop
		Flashing	Refrigeration delay
Defrosting indicator	❄️	On	Defrosting working
		Off	Defrosting stop



Fan indicator		On	Fan start
		Off	Fan close
Defrosting drip indicator	drip	On	Defrosting drip start
		Off	Defrosting drip finish
Door signal indicator		On	Door switch open
		Off	Door switch close

4. Key functions

4.1 Key name

Key name	Function
Set	Enter parameter setting status
	Switch menu and parameter
	Adjust menu and parameter
	Open/close light (only effective to the model with light controller)
	Adjust menu and parameter
	View the evaporator sensor temperature
	Exit the parameter setting status
	Forcibly switch among refrigeration, defrosting/defrosting delay and defrosting drip if it lasts for 3s

4.2 Parameter adjustment

Press **Set** for 3s in the measurement and control status to enter the user menu and display St. Press **Set** again to display St parameter value. Modify the setting temperature value by operating  or ; press  or make keyless operation for 30s to exit the parameter setting and automatically save the current parameter value.

4.3 Temperature view: press  in the measurement and control status to view current measured value of the evaporator sensor temperature (evaporator sensor is enabled and normal)

4.4 Manual imperative operation

Press  for 3s in the measurement and control status for forcible switch among refrigeration, defrosting/defrosting delay and defrosting drip

Alarm code	Cause
E1	Refrigerator temperature sensor fault
E2	Evaporator sensor fault
E3	Condenser sensor fault
cH	Condenser high temperature alarm
rH	Refrigerator temperature high temperature alarm
rL	Refrigerator temperature low temperature alarm

Alarm code	Cause
Er	Copy card programming failed
EP	Inconsistent data in the copy card with controller model, programming failed

IX. Warranty and service

Thanks again for selecting our supermarket refrigerator products. To protect your deserved interest and make you assured, the company will provide you with maintenance services and technical support. Please carefully read the following content to obtain quick and convenient services.

1 Maintenance service guide

(1) After buying the supermarket refrigerator, check whether the physical refrigerator is consistent with the packing list and whether the attached documents are complete. For any objection, please immediately contact the dealer or the company.

(2) Please properly keep the repair bill and relevant materials.

(3) In case of fault in your supermarket refrigerator, observe and check according to the requirements in the table in Item 6 above. The fault caused by mis operation or use or improper maintenance may be eliminated by yourself or handled by the maintenance personnel of the company or the dealer.

(4) If the fault in the equipment cannot be eliminated, immediately contact our maintenance service department and we will help to solve as soon as possible.

2 Limited warranty clause

- (1) "Kaixue" supermarket refrigerator is provided with free warranty for one year after the date of purchase. The refrigerator that has been declared as disposed product at the purchase is not within the warranty.
- (2) This warranty clause applies to the mainland region of the People's Republic of China.
- (3) This warranty clause applies only to the products directly purchased by the customer from the company or from the retailer approved by the company.
- (4) The warranty bill sealed by the company or by the retailer approved by the company is the unique voucher for warranty. If you are required by the warranty unit to provide the voucher, you should show the warranty bill.
- (5) The product that has been subject to warranty may be subject to warranty again in the remaining warranty period or within 90 days after warranty, whichever is longer.
- (6) The costs for transporting the product to the warranty unit and transporting back are not free.
- (7) The product warranty is only for the quality problems caused by insufficient product quality in improper construction and installation. The problems caused by improper transportation, installation, use or management of the consumer and other non-product reasons are not included in the warranty.
- (8) The occurrence of the warranty time is subject to the time when the consumer notifies the company of the product defect. The products not enjoying warranty may be repaired by the company, but the

costs will be collected according to relevant provisions.

☆ In case of product upgrade, some parameters in the manual may be changed without further notice. The physical product shall prevail and the company reserves the final power of interpretation.