

# Woltman Turbine Meter

## Magnetic Drive Dry Type

WPH

Heavy duty and designed to handle high flow rates, the TURBOBAR WPH-Magnetic Drive water meter covers a very wide flow range, and is particularly suited to industrial, waterworks, water distribution, water monitoring, and agricultural applications. Based on the Woltmann principle, the helical blades of the turbine rotate around the axis of flow. TURBOBAR products are long-life, and easy to maintain at low cost.



EEC CLASS B  
PATTERN APPROVAL

### Features and Benefits

- Removable and interchangeable measuring element
- Dry type register
  - Hermetically sealed
- Includes output option by Dry Contact (Reed Switch) and Opto-Electronic sensor, as standard
  - Digital flow converter device and a digital counter are available on request
- Magnetic transmission keeps the register completely separate from water; only the impeller and transmission shaft contact water
- Meets or exceeds ISO 4064 class B-H
- US gallons registration available on request
- EEC Approval (50-300 mm)

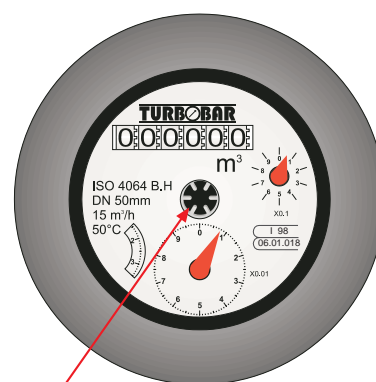

Rotating star for leak detection and electronic calibration

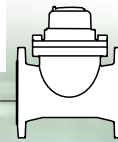

# BERMAD Irrigation

## Water Meter Series

### Technical Specifications

#### Dimensions and Weights

	in	1 1/2"	2"	2 1/2"	3"	4"	5"	6"	8"	10"	12"	16"	20"
Size	DN	40	50	65	80	100	125	150	200	250	300	400	500
		ISO	ANSI/BSTD										
L - Length (mm)		260	200	310	200	225	250	250	300	350	450	500	500
H - Height (mm)		268	275	270	285	295	304	318	366	393	512	534	669
H <sub>1</sub> - Height (mm)		338	345	340	355	365	374	388	436	463	582	604	739
h - Height (mm)		68	75	70	85	95	104	118	135	162	194	216	304
W - Width (mm)		160	170	160	190	200	230	250	285	340	395	445	600
Weight (kg)		13	12	15	14	16	19	20	39	52	105	120	187

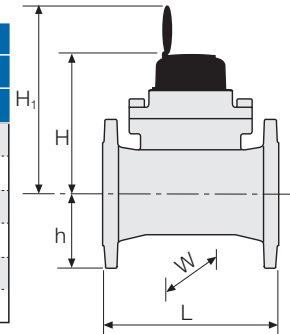

#### Accuracy Curve

	in	1 1/2"	2"	2 1/2"	3"	4"	5"	6"	8"	10"	12"	16"	20"	
	DN	40	50	65	80	100	125	150	200	250	300	400	500	
Q <sub>n</sub> - Nominal flow rate (ISO 4064) (m <sup>3</sup> /h)		10	15	25	40	60	100	150	250	400	600	1,000	1,500	
Q <sub>p</sub> - Max. Permanent flow (m <sup>3</sup> /h)		20	30	30	60	100	160	180	300	600	1,000	1,500	3,000	
Q <sub>max</sub> - Max. flow rate (ISO 4064) (m <sup>3</sup> /h)		20	30	50	80	120	200	300	500	800	1,200	2,000	3,000	
Max. flow peak duty (m <sup>3</sup> /h)		30	50	80	120	200	250	300	500	800	1,500	2,500	4,000	
Q <sub>t</sub> - Transmition flow rate (±2%) (m <sup>3</sup> /h)		3	3	5	8	12	20	30	50	80	120	200	300	
Q <sub>min</sub> - Min. flow rate (±5%) (ISO 4064) (m <sup>3</sup> /h)		0.7	0.45 0.7	0.75	1.2	1.8	3	4.5	7.5	12	18	30	40	
Flow rate Δp = 0.1 bar (m <sup>3</sup> /h)		30	40	55	60	90	120	300	500	850	1,500	3,000	5,000	
Max. reading (m <sup>3</sup> )		1,000,000						10,000,000			100,000,000			
Min. reading (liter)		1						10			100			

#### Accuracy Curve

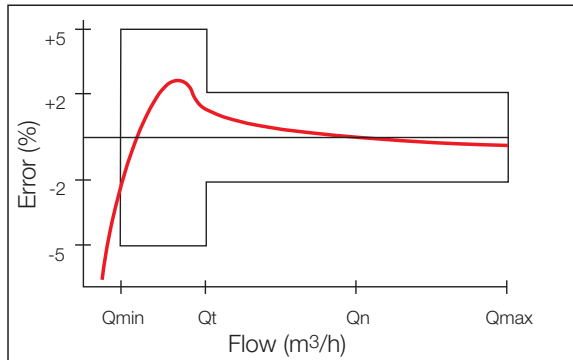

#### Flow Curve

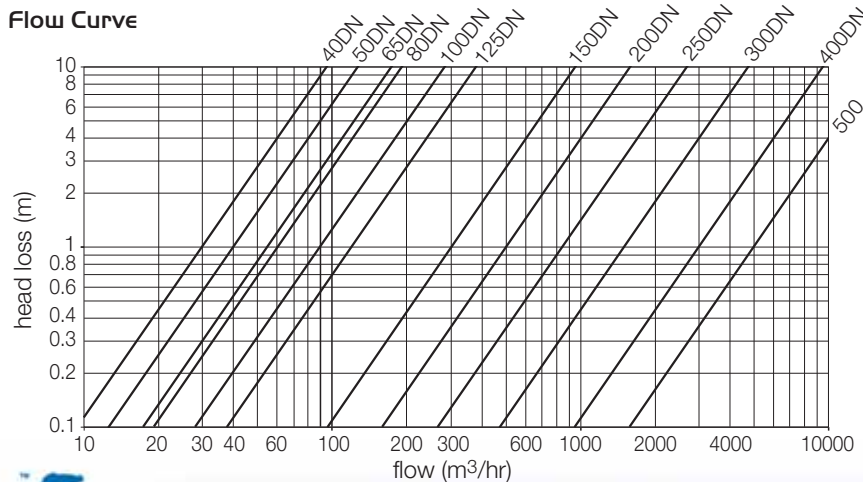

#### Main Operating Characteristics

- Pressure Rating: PN 16
- Temperature: 50°C

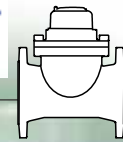

### Data Output Options

Water system management requires reliable data acquisition. The TURBOBAR WPH provides accurate data acquired directly from within the system.

#### Pulse Generating Options

- The reed switch pulse transmitter is a magnetic on/off switch that makes and breaks electric pulse contact per each unit of flow.
- The Opto-Electronic Sensor (infrared retro-reflective photocell) produces an electric pulse with high pulse-rate capacity. The pulse is transmitted to a converter\* that enables instant flow-rate readout, pulse counting, and/or 4-20 mA output.

\*Converter available on request.

### Data Output Options

#### Reed Switch

- Switching voltage: 48 VAC/DC max
- Switching current: 0.2 A max
- Switching power: 4 W max

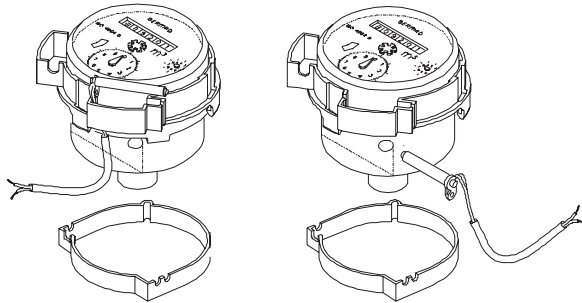

Register with Reed Switch

#### Opto-Electronic Sensor

- Supply voltage: 5-10 VDC
- Output type: PNP
- Output signal
  - High state: • supply voltage
  - Low state: <0.5 VDC

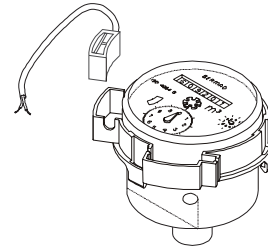

Register with Opto-Electronic Sensor

### Pulst Options

Size		1 Pulse for Each							
		Reed Switch				Opto-Electronic Sensor			
In	mm	10 liter	100 liter	1 m <sup>3</sup>	10 m <sup>3</sup>	100 m <sup>3</sup>	1 liter	10 liter	100 liter
1 1/2"	40	•	X	X			X		
2"	50	•	X	X			X		
2 1/2"	65	•	X	X			X		
3"	80	•	X	X			X		
4"	100	•	X	X			X		
5"	125	•	X	X			X		
6"	150		•	X	X			X	
8"	200		•	X	X			X	
10"	250		•	•	X	X		•	X
12"	300			•	X	X			X
16"	400			•	X	X			X
20"	500			•	X	X			X
Order Codes		S4	S3	S2	S1	S8	SA	SB	SC

Pulse in US gallons available on request.  
All factory configured options are field accessible.

X Factory configured standard.  
• Factory configured on request.

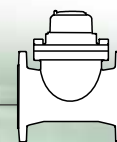

### Installations Recommendation

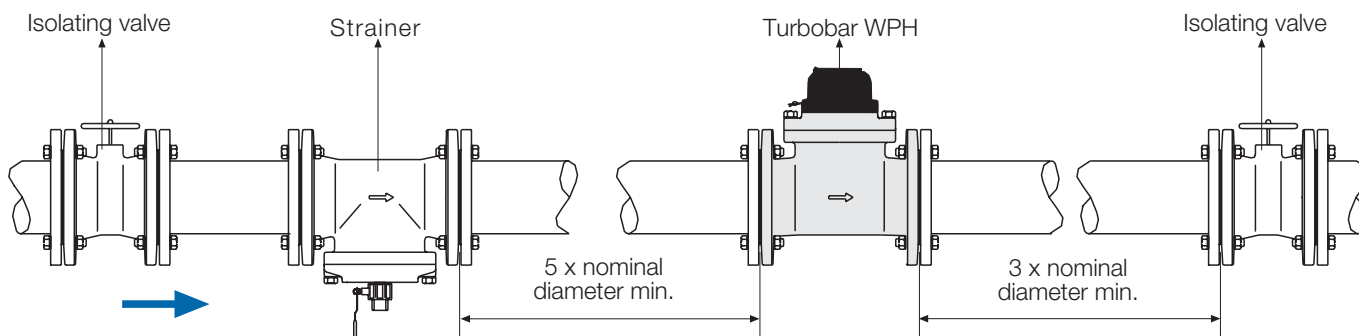

### Installation Considerations

Proper installation helps maximize the accuracy and life-span of the TURBOBAR WPH.

All turbine meters are sensitive to turbulent conditions caused by diameter changes, pumps, tees, valves, etc.

Therefore, install the meter far from these disturbances and according to the following specifications:

- Upstream - 5 diameters min.
- Downstream - 3 diameters min.

### Recommendation

Install a strainer upstream of the TURBOBAR WPH to eliminate debris that could damage or stop operation of the measuring element.

### Caution

- Prior to installing a TURBOBAR WPH in a new line, flush the line to remove debris.
- Ensure that the TURBOBAR WPH is full of water during measuring.

### Ordering Guide

Please specify the requested valve in the following sequence: (for more options, refer to Ordering Guide)

Example: WPH-K - 50 - 16 - M3 - PB - S4

WPH-K		50		16		M3		PB		S4	
<b>Type</b>	<b>Size</b>	<b>Code</b>	<b>End Conections</b>	<b>Code</b>	<b>Measuring Unit</b>	<b>Code</b>	<b>Coating</b>	<b>Code</b>	<b>Pulse Options</b>	<b>Code</b>	
WPH-K	1 1/2" - 40 mm	40	ISO-16	16	Cubic Meter	M3	Polyester Green	PG	<b>1 Pulse Per Reed Switch</b>		
	2" - 50 mm	50	ANSI-125	A1	Gallon	GAL	Polyester Blue	PB	10 Liter / 1 Gal	S4	
	2 1/2" - 65 mm	65	BSTD	BD			Epoxy Blue	EB	100 Liter / 10 Gal	S3	
	3" - 80 mm	80	ABNT	B6					1 m <sup>3</sup> / 100 Gal	S2	
	4" - 100 mm	100	JIS	J1					10 m <sup>3</sup> / 1000 Gal	S1	
	5" - 125 mm	125	ASTE	SE					100 m <sup>3</sup> / 10000 Gal	S8	
	6" - 150 mm	150	ASTD	SD					<b>1 Pulse Per Opto Electronic Sensor</b>		
	8" - 200 mm	200							1 Liter / 0.1 Gal	SA	
	10" - 250 mm	250							10 Liter / 1 Gal	SB	
	12" - 300 mm	300							100 Liter / 10 Gal	SC	
	16" - 400 mm	400									
	20" - 500 mm	500									



Trädgårdsteknik AB  
Helsingborgsvägen 578  
262 96 ÄNGELHOLM  
Telefon: 0431-222 90  
Telefax: 0431-222 70  
info@tradgardsteknik.se  
www.tradgardsteknik.se