

NOTES:

1. HOLD ROUGH-IN DIMENSIONS ± 1/8" (3.2mm)
2. WHEN INSTALLING THIS UNIT, LOCAL, STATE, OR FEDERAL CODES SHOULD BE ADHERED TO. FOR INSTALLATION HEIGHTS OTHER THAN SHOWN, DIMENSIONS MARKED (*) MUST BE ADJUSTED ACCORDINGLY.
3. REFER TO MTGFR.17 INSTALLATION DRAWING FOR FRAME ROUGH-IN DIMENSIONS.
4. REFER TO 5874 SERIES OPERATION AND MAINTENANCE MANUAL FOR PUSH BUTTON AND VALVE INSTALLATION/MAINTENANCE INSTRUCTIONS.
5. ROUGH-IN DIMENSIONS FOR FOUNTAIN HEIGHTS:

CHILD WHEELCHAIR HEIGHT: SEE SHEET 2 FIG 1
 WASTE: 26-1/4" (667mm)
 FOUNTAIN: 24" (610mm)
 BUBBLER: 29-7/8" (756mm)

ADULT WHEELCHAIR HEIGHT: SEE SHEET 2 FIG 2
 WASTE: 29-1/4" (743mm)
 FOUNTAIN: 27" (686mm)
 BUBBLER: 32-7/8" (832mm)

ADULT STANDING HEIGHT: SEE SHEET 2 FIG 3
 WASTE: 34-3/4" (883mm)
 FOUNTAIN: 32-1/2" (826mm)
 BUBBLER: 39-3/8" (972mm)

6. REFER TO MODEL H1117.8 INSTALLATION DRAWING SHEET 2 OF 2 (ON HAWS WEBSITE WWW.HAWSCO.COM) FOR PERMISSIBLE BOWL MOUNTING PATTERNS. TWO WHEELCHAIR HEIGHT FOUNTAINS CANNOT BE MOUNTED SIDE BY SIDE PER ANSI A117.1

NOTES CONTINUED ON SHEET 2 OF 2

IMPORTANT: MOUNTING FRAME MUST BE INSTALLED SO THAT LIP OF FRAME SITS AGAINST FINISHED WALL FACE.

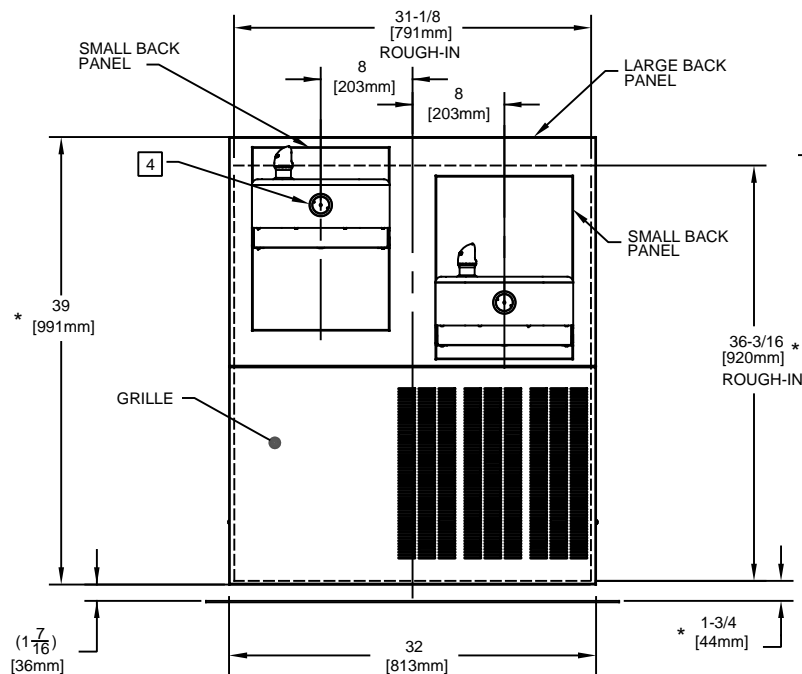
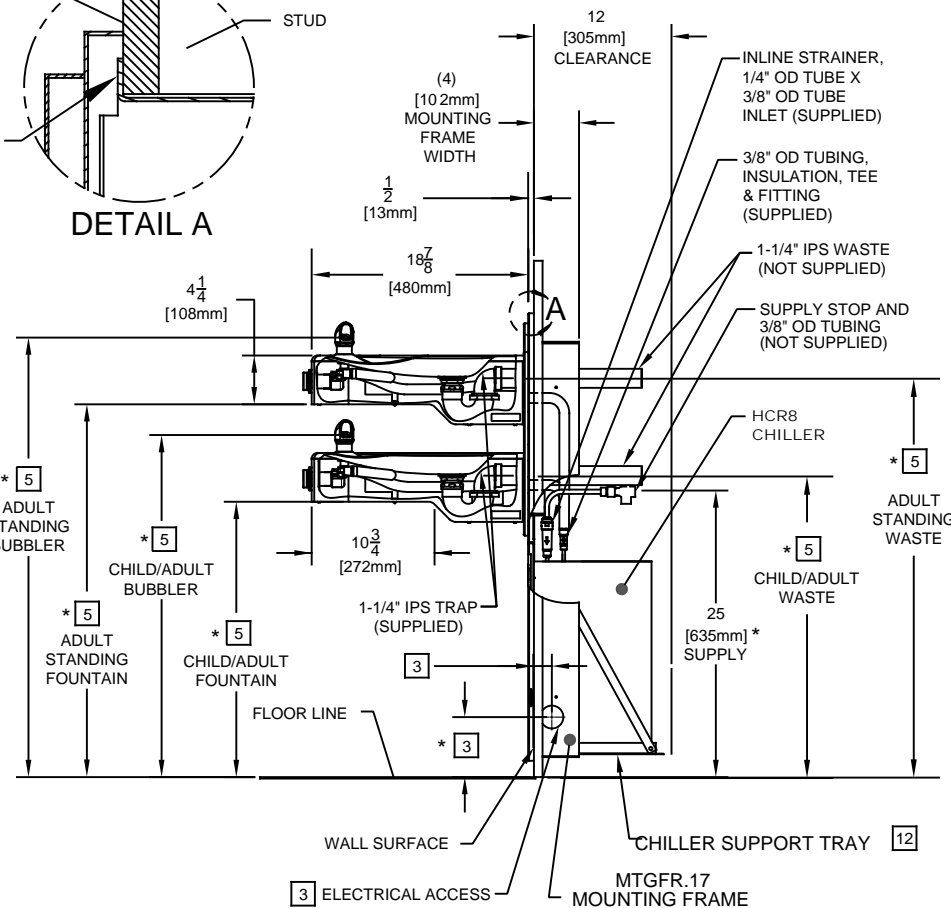
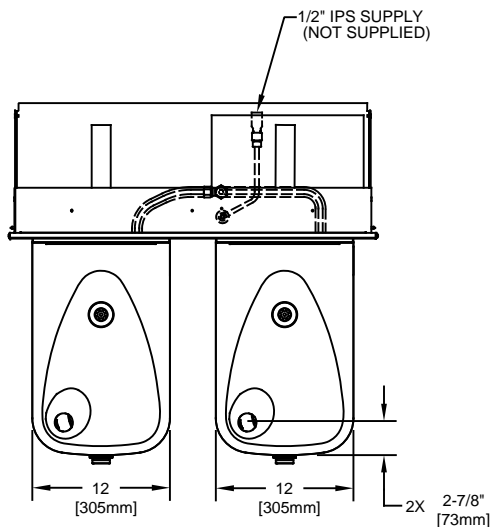
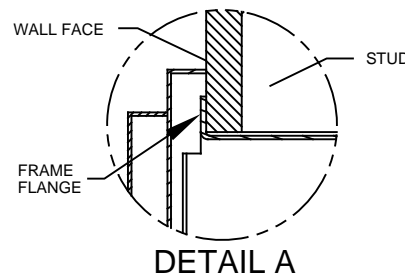

1455 KLEPPE LANE
 SPARKS, NEVADA 89431
 (775) 359-4712 FAX (775) 359-7424
 E-MAIL: HAWS@HAWSCO.COM
 WEBSITE: WWW.HAWSCO.COM

ECN NO. 3817	REVISED PER ECN: 5190	BY: JP	MODEL(S) H1117.8
DRAWN: C.FENNER	DATE: 10-25-06	CHKD.: FV	PART NUMBER 0002080215.D
APPROVED: FV	DATE: 07/07/17	SCALE: N/A	REVISION 11
DRAWING TYPE: INSTALLATION		SIZE: A SHEET 1 OF 2	

NOTES:

- 7 FIGURES 1 AND 2 ARE REVERSIBLE. CAN BE RIGHT OR LEFT SIDE HIGH.
- 8 USE SHADED HOLES TO MOUNT BOWLS AT INDICATED POSITIONS BASED ON COMBINATION SELECTED (FIGS. 1 THRU 3).
- 9. REFER TO SHEET 1 OF 2 NOTE 5 FOR INSTALLED FOUNTAIN DIMENSIONS.
- 10 INSERT 5/16"-18 PANEL NUT RETAINERS FROM OPPOSITE SIDE AT LOCATIONS SELECTED (SHOWN BY DARKENED HOLES). HOLE COMBINATION SHOWN (INSET) IS FOR REF. ONLY
- 11 TO CHANGE FOUNTAIN MTG. SCREW LOCATIONS: FIRST REMOVE SCREWS AND THEN SQUEEZE CLIPS ON NUT RETAINER TO POP OUT. SNAP INTO NEW POSITIONS AND RE-ASSEMBLE SCREWS.
- 12 ALIGN HOLES IN CHILLER SUPPORT TRAY WITH HOLES IN FRAME AND FASTEN WITH #10 SHEETMETAL SCREWS.

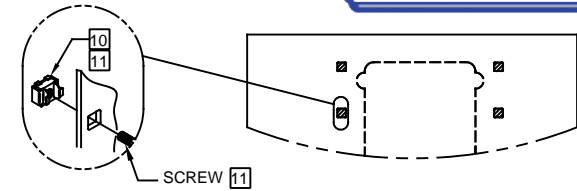

BOWL MOUNTING DETAIL

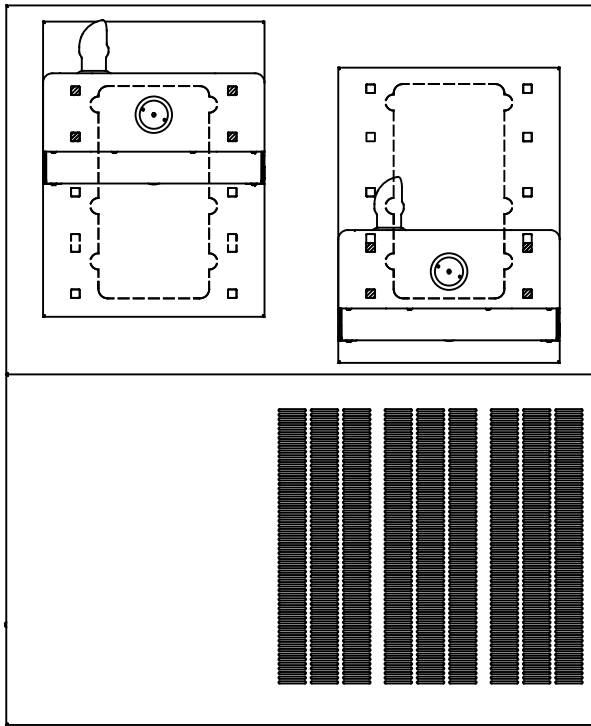

7

FIGURE 1.

ADULT STANDING/CHILD WHEELCHAIR

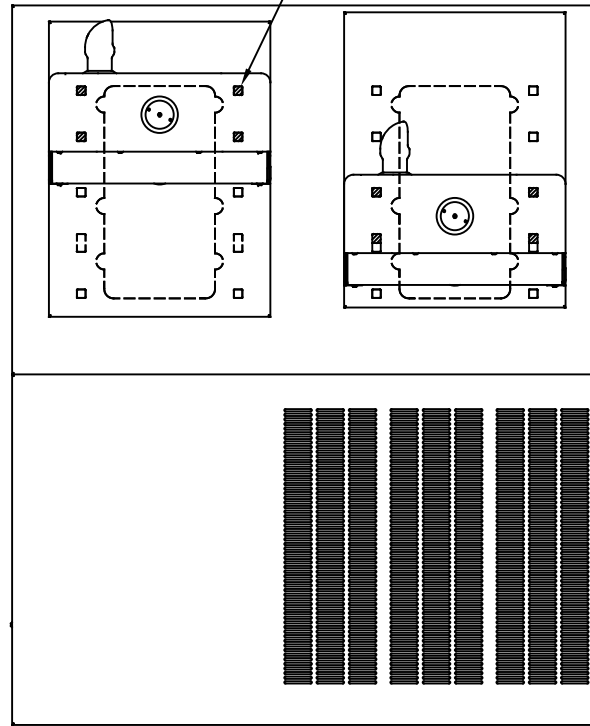

7

FIGURE 2.

ADULT STANDING/ADULT WHEELCHAIR

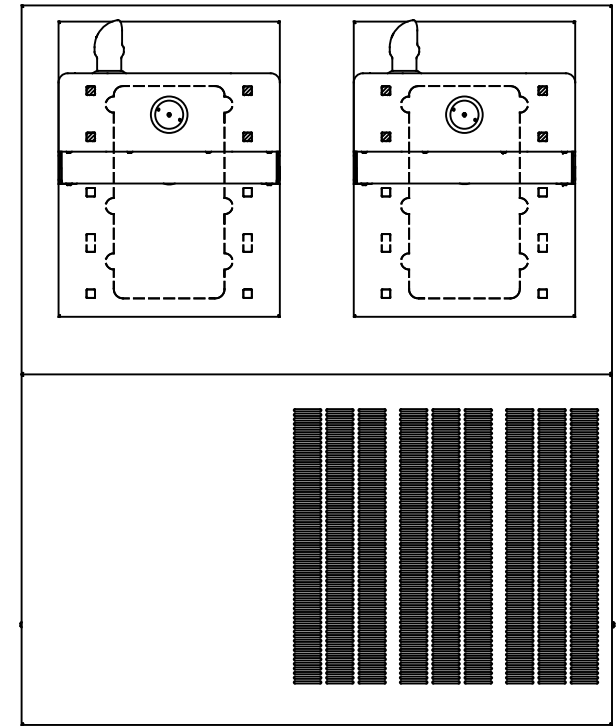

FIGURE 3.

ADULT STANDING/ADULT STANDING

BOWL MOUNTING PATTERNS



Haws

1455 KLEPPE LANE
SPARKS, NEVADA 89431
(775) 359-4712 FAX (775) 359-7424
E-MAIL: HAWS@HAWS.CO.COM
WEBSITE: WWW.HAWS.CO.COM

ECN NO. 3817	REVISED PER ECN: 5190	BY: JP	MODEL(S)	PART NUMBER
DRAWN: C.FENNER	DATE: 10-25-06	CHKD.: FV	H1117.8	0002080215.D
APPROVED: FV	DATE: 07/07/17			REVISION 11
SCALE: N/A		DRAWING TYPE: INSTALLATION		SIZE: A SHEET 2 OF 2